

DRAINAGE FOR AGRICULTURE

DRAINAGE AND HYDROLOGY/SALINITY
Water and salt balances

R.J. Oosterbaan

On website <https://www.waterlog.info>

*Lecture notes on:
water and salt balances of the soil,
drainage and soil salinity*

International Course on Land Drainage (ICLD)

International Institute for Land Reclamation and
Improvement (ILRI), Wageningen, The Netherlands

DRAINAGE AND HYDROLOGY/SALINITY
Water and salt balances

Table of contents

1	DRAINAGE AND HYDROLOGY.....	1
1.1	Water balances of agricultural land.....	1
1.2	The surface reservoir.....	4
1.3	The root zone.....	4
1.4	The transition zone.....	5
1.5	The aquifer.....	5
1.6	Combined balances.....	5
1.7	Water table above the soil surface.....	7
1.8	Water table in the root zone.....	7
1.9	Water table in the aquifer.....	7
1.10	Reduced number of reservoirs.....	7
1.11	Steady state.....	8
1.12	Net and excess values.....	9
2	EXAMPLES OF WATER BALANCES.....	10
3	SALT BALANCES, Leaching.....	19
4	EXAMPLES OF SALT BALANCES.....	23

1 DRAINAGE AND HYDROLOGY

1.1 Water balances of agricultural land

In Figure 1.1 the soil profile is divided into four different reservoirs.

- s: Reservoir above the soil surface (surface reservoir)
- r: Reservoir below the soil surface from which evapo-transpiration takes place. Normally, this reservoir is taken equal to the root zone.
- x: Reservoir of the transition zone between root zone and aquifer. Its lower limit can be fixed in different ways according to local conditions:
 - 1 - at the interface between a clay layer on top of a sandy layer, provided that the water table remains above the interface
 - 2 - at the annually deepest depth of the water table
 - 3 - at the deepest depth to which the influence of a subsurface drainage system extends
 - 4 - at the depth where horizontal groundwater flow is converted into vertical flow of groundwater or vice versa.
- q: Reservoir of the aquifer resting on an impermeable layer.

Each reservoir has incoming and outgoing groundwater factors as shown in the figure. The water balance is based on the principle of the conservation of mass for boundaries defined in space and time and can be written as:

$$\text{Inflow} = \text{Outflow} + \Delta W \quad (1.1)$$

where: ΔW is the change in water storage

When the change in storage is positive, the water content increases and, when negative (i.e. there is depletion instead of storage), it decreases.

The ΔW values of the different reservoirs can be indicated by ΔW_s , ΔW_r , ΔW_x and ΔW_q respectively.

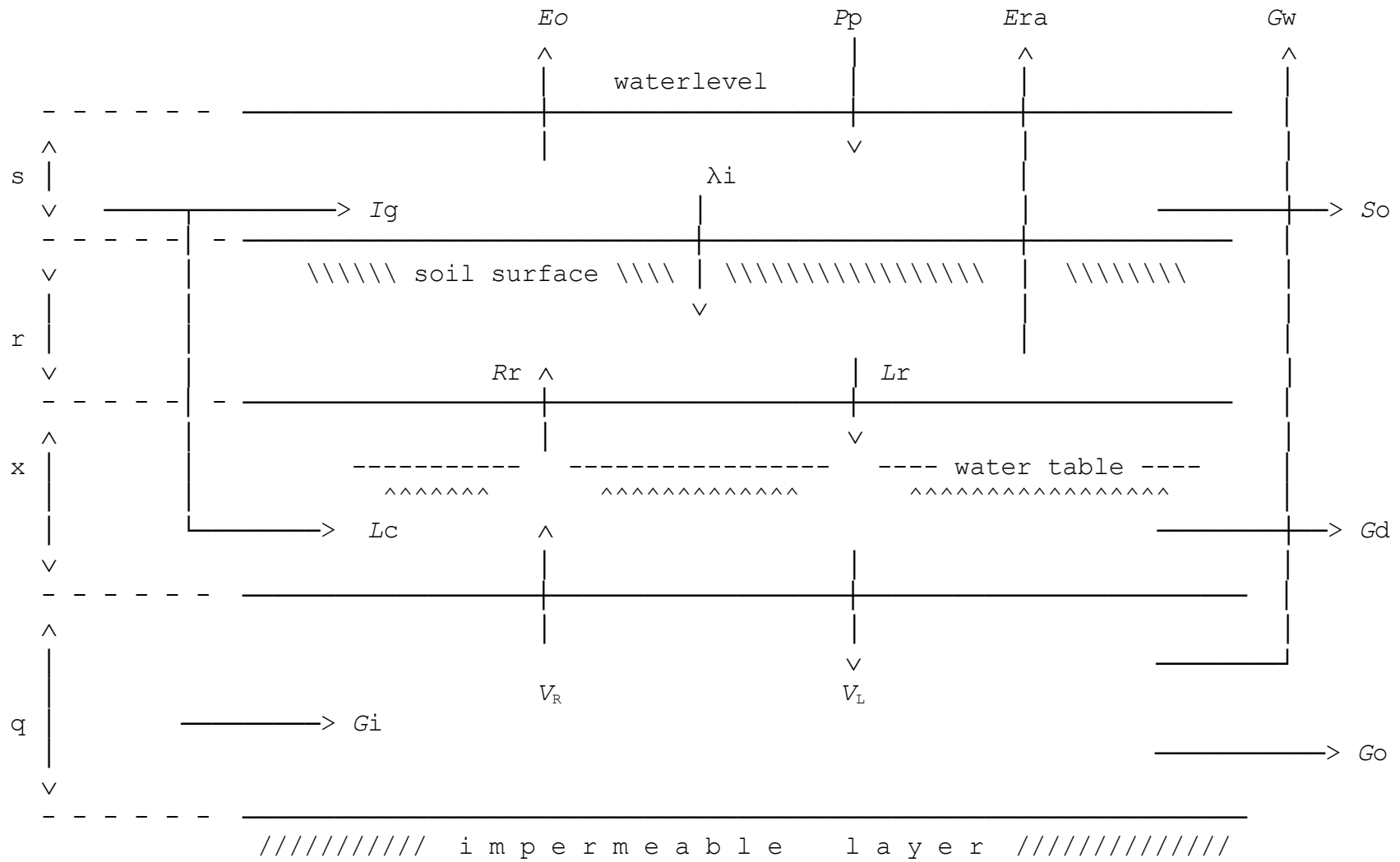

Figure 1.1 The concept of 4 reservoirs with hydrological inflow and outflow components

LIST OF SYMBOLS

Water balance factors in figure 1.1

- E_o Evaporation from open water on the soil surface.
- E_{ra} Actual evapo-transpiration from the root zone.
When the root zone is moist, it equals the potential evapo-transpiration E_p , otherwise it will be less.
- G_d Subsurface drainage, natural (G_{dn}) or artificial (G_{da}), to channels, ditches or pipe systems. The suffixes "dn" and "da" are not used in the given water balances, but can be introduced.
- G_i Horizontally incoming groundwater into the aquifer.
- G_o Horizontally outgoing groundwater from the aquifer.
- G_w Pumping from wells placed in the aquifer.
- I_g Horizontally incoming surface water. This can consist of natural inundation and/or gross surface irrigation.
- L_c Infiltration, from river or canal systems into the transition zone, often referred to as seepage losses from canals.
- L_r Percolation of water from the unsaturated root zone into the transition zone.
- λ_i Infiltration of water through the soil surface into the root zone.
- P_p Downwardly incoming water to the surface: precipitation (incl. snow), rainfall, sprinkler irrigation.
- R_r Capillary rise of water from the transition zone into the unsaturated root zone, i.e. the water table is below the root zone.
- S_o Surface runoff (natural, S_{on}) or surface drainage (artificial, S_{oa}). The suffices "on" and "oa" are not used in the given water balances, but can be introduced.
- V_R Vertically upward seepage of water from the saturated aquifer into the transition zone.
- V_L Vertically downward drainage of water from the saturated transition zone into the aquifer.

Assuming the water table to be in the transition zone, the following water balances can be made for each reservoir using the symbols shown in the figure and explained in the list of symbols.

1.2 The surface reservoir

The surface reservoir (s) is located on top of the soil. The water balance of the surface reservoir for a certain period reads:

$$P_p + I_g = E_o + \lambda_i + S_o + \Delta W_s \quad (1.2)$$

where: P_p is the amount of water vertically reaching the soil surface, such as precipitation and sprinkler irrigation, I_g is the gross irrigation inflow including the natural surface inflow and the drain and well water used for irrigation, but excluding the percolation losses from the canal system, E_o is the amount of evaporation from open water, λ_i is the amount of water infiltrated through the soil surface into the root zone, S_o is the amount of surface runoff or surface drainage leaving the area, and ΔW_s is the change in amount of water stored in the surface reservoir.

1.3 The root zone

The root zone (r) corresponds to the depth of soil from which evapo-transpiration takes place. Its water balance reads:

$$\lambda_i + R_r = E_{ra} + L_r + \Delta W_r \quad (1.3)$$

where: R_r is the amount of capillary rise into the root zone, E_{ra} is the amount of actual evapo-transpiration from the root zone, L_r is the amount of percolation losses from the root zone, ΔW_r is the storage of water in the root zone.

The factor R_r is the opposite of L_r and these components cannot occur simultaneously, i.e. when $R_r > 0$ then $L_r = 0$ and vice versa.

When water balances are made for fairly long periods of time, for instance a season or a year, the storage ΔW_r is often negligibly small compared to the other hydrological components. Therefore, this storage is set equal to zero and the water balance 1.3 changes to:

$$\lambda_i + R_r = E_{ra} + L_r \quad (1.4)$$

In the root zone, there are only vertical, no horizontal water movements.

1.4 The transition zone

The transition zone (x) is the zone between root zone and aquifer. Its lower limit can be fixed in different ways according to local conditions: (a) at the interface between a clay layer on top of a sandy layer, (b) at the annually greatest depth to water table, (c) at the greatest depth to which the influence of a subsurface drainage system extends, (d) at the depth where horizontal groundwater flow is converted into vertical flow of groundwater or vice versa. The water balance of the transition zone, reads:

$$L_r + L_c + V_r = R_r + V_L + G_d + \Delta W_x \quad (1.5)$$

where: L_c is the percolation loss from the irrigation canal system, V_r is the amount of vertical upward seepage from the aquifer into the transition zone, V_L is the amount of vertical downward drainage from the saturated transition zone to the aquifer, G_d is the total amount of natural or artificial drainage of groundwater to ditches or pipe drains, and ΔW_x is the water storage in the transition zone.

The component V_r is the opposite of V_L and these cannot occur simultaneously, i.e. when $V_r > 0$ then $V_L = 0$ and vice versa.

1.5 The aquifer

The water balance of the aquifer (q) can be written as:

$$G_i + V_L = G_o + V_r + G_w + \Delta W_q \quad (1.6)$$

where: G_i is the amount horizontal groundwater inflow through the aquifer, G_o is the amount of horizontal groundwater outflow through the aquifer, G_w is the amount groundwater pumped from the aquifer through wells, and ΔW_q is the groundwater storage in the aquifer.

When the aquifer is not elastic (compressible or de-compressible) and the aquifer is saturated, the value of ΔW_q is zero.

1.6 Combined balances

When the water table is in the transition zone, the balances of the surface reservoir and the root zone may be combined in to

the topsoil water-balance, by adding balances 1.2 and 1.3 and using

$$E_a = E_o + E_{ra} \quad (1.7)$$

where E_a is the total actual evapo-transpiration. This gives:

$$P_p + I_g + R_r = E_a + S_o + L_r + \Delta W_s + \Delta W_r \quad (1.8)$$

In the topsoil water-balance, the infiltration component λ_i is not present. This component is a vertical flow linking the two reservoirs. It is called a linkage component. Using:

$$I_f = I_g - S_o \quad (1.9)$$

$$V_s = P_p + I_f \quad (1.10)$$

where I_f is the net field irrigation and V_s represents the net surface water resource, balance 1.8 can be reduced to:

$$V_s + R_r = E_a + L_r + \Delta W_r + \Delta W_s \quad (1.11)$$

With a water table in the transition zone, the balances of the transition zone (1.5) and aquifer (1.6) can be combined into the geo-hydrologic water balance, in which the storage ΔW_q may be considered zero as the aquifer is fully saturated:

$$L_r + L_c + G_i = R_r + G_o + G_d + G_w + \Delta W_x \quad (1.12)$$

Here, the linkage components V_R and V_L have vanished.

It is also possible to combine three reservoirs. For example, joining the water balances of the surface reservoir (1.2), root zone (1.3), and transition zone (1.5), gives the agronomic water-balance:

$$P_p + I_g + L_c + V_R = S_o + E_a + G_d + V_L \\ + \Delta W_s + \Delta W_r + \Delta W_x \quad (1.13)$$

Here, the linkage components R_r and L_r have vanished.

When the water table is not in the transition zone, it may be above the soil surface, in the root zone, or in the aquifer. The balances can be adjusted accordingly as discussed below.

1.7 Water table above the soil surface

When the water table remains above the soil surface, the values of ΔW_r , ΔW_x and ΔW_q are zero, as the soil is fully saturated. When, in addition, the water flows from the subsoil into the surface reservoir, the infiltration λ_i becomes negative. Thus, it is preferable to combine the water balances of all the reservoirs (1.2, 1.3, 1.5, and 1.6):

$$P_p + I_g + L_c + G_i = E_a + S_o + G_o + G_d + G_w + \Delta W_s \quad (1.14)$$

In this overall water balance, all linkage components have disappeared.

1.8 Water table in the root zone

When the water table is in the root zone, the capillary rise R_r and percolation L_r do not exist, because the transition zone is saturated. Also, the values of ΔW_x and ΔW_q are zero. Thus it is preferable to combine the water balances of root zone (1.3), transition zone (1.5) and aquifer (1.6), giving the subsoil water balance:

$$\lambda_i + L_c + G_i = E_{ra} + G_o + G_d + G_w + \Delta W_r \quad (1.15)$$

1.9 Water table in the aquifer

When the water table is in the aquifer, the saturated, vertical, flows into or from the transition zone (V_R and V_L) do not exist. In this case one can use either the geo-hydrologic (1.12) or the subsoil (1.14) water balances.

1.10 Reduced number of reservoirs

When one of the four reservoirs is not present, the balances become simpler. For example, when there is no aquifer, the geo-hydrologic water-balance (1.12) no longer exists as it will be reduced to the transition zone balance (1.5) with $V_L = 0$ and $V_R = 0$. Also, the subsoil water-balance (1.15) will be reduced to:

$$(1.15r) \quad \lambda_i + L_c = E_{ra} + G_d + G_w + \Delta W_r$$

and the overall water balance (1.14) to:

$$(1.14r) \quad P_p + I_g + L_c = E_a + S_o + G_d + G_w + \Delta W_s$$

When two or more reservoirs are absent, the water balance equations become still more simple. Examples will not be given.

1.11 Steady state

When the water balances are made for fairly long periods (e.g. per season or per year), in many cases the ΔW values (changes in storage) are small compared to the values of the other factors (components) of the water balance. Then, the ΔW values can be ignored, so that the water balances can be simplified. When Δ is taken zero, i.e. the amounts of all incoming and all outgoing water are equal, one obtains a steady state.

Therefore, over fairly long periods of time, the water balance can often be considered in steady state. For example, the water balance of the transition zone (1.5) in steady state is:

$$(1.5s) \quad L_r + L_c + V_r = R_r + V_L + G_d$$

The geo-hydrologic water balance (1.12) in steady state is:

$$(1.12s) \quad L_r + L_c + G_i = R_r + G_o + G_d + G_w$$

while the agronomic water balance (1.13) in steady state is:

$$(1.13s) \quad P_p + I_g + L_c + V_r = S_o + E_a + G_d + V_L$$

The overall water balance (1.14) in steady state will be

$$(1.14s) \quad P_p + I_g + L_c + G_i = E_a + S_o + G_o + G_d + G_w$$

and the subsoil water balance (1.15) in steady state becomes:

$$(1.15s) \quad \lambda_i + L_c + G_i = E_{ra} + G_o + G_d + G_w$$

All the above examples of steady state balances contain the subsurface drainage component (G_d), so there are different expressions available to calculate this component depending on the availability of data.

1.12 Net and excess values

Linkage factors along the same reservoir boundary having arrows pointing in opposite direction, especially percolation L_r versus capillary rise R_r and upward seepage V_R versus downward drainage V_L , cannot occur at the same time but they can occur alternately in different periods of time. Over a longer period of time, one factor will be greater than the other and they can be combined into net values. For example:

$$(1.16c) \quad R_{rn} = R_r - L_r \quad \text{Net capillary rise}$$

$$(1.16p) \quad L_{rn} = L_r - R_r \quad \text{Net percolation}$$

Note that $R_{rn} > 0$ when $L_{rn} = 0$ and $L_{rn} > 0$ when $R_{rn} = 0$.

$$(1.17u) \quad V_{rn} = V_R - V_L \quad \text{Net upward seepage}$$

$$(1.17d) \quad V_{ln} = V_L - V_R \quad \text{Net downward drainage}$$

Note that $V_{rn} > 0$ when $V_{ln} = 0$ and $V_{ln} > 0$ when $V_{rn} = 0$.

The horizontal inflow (G_i) and outflow (G_o) of groundwater, which have arrows pointing in the same direction can be combined into excess values:

$$(1.18i) \quad G_{iN} = G_i - G_o > 0 \quad \text{Excess inflow over outflow}$$

$$(1.18o) \quad G_{oN} = G_o - G_i > 0 \quad \text{Excess outflow over inflow}$$

Note that $G_{iN} > 0$ when $G_{oN} = 0$ and $G_{oN} > 0$ when $G_{iN} = 0$.

With the net and excess values, the previous balances can be simplified further. For example, the steady state balance of the aquifer (see 1.6, with $\Delta W_q = 0$), can now be written as:

$$G_{iN} = V_{rn} + G_w \quad (1.16inR)$$

$$\text{or:} \quad G_{iN} = G_w - V_{ln} \quad (1.16inL)$$

$$\text{or:} \quad G_{oN} = V_{ln} - G_w \quad (1.19oN)$$

2 EXAMPLES OF WATER BALANCES

Example 2.1

An example of the surface water balance is given in Figure 2.1, giving the relation between surface runoff and rainfall. The principle illustrated in the figure is used in the Curve Number Method (Chapter 4.4, Publ. 16, ILRI, 1994).

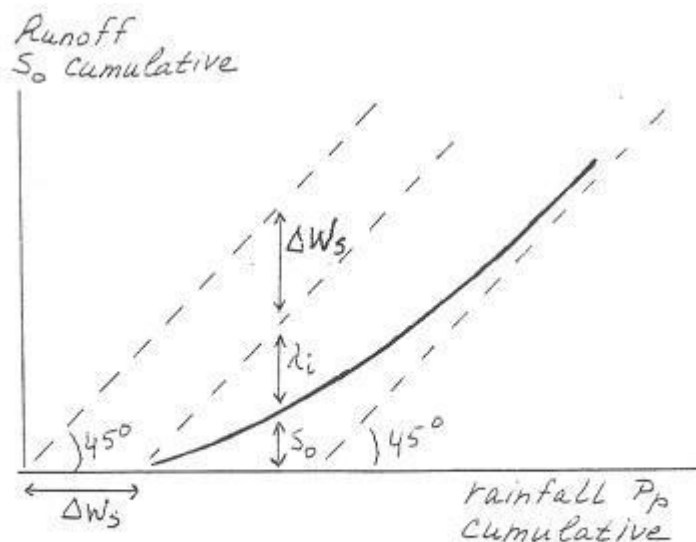

Figure 2.1 Illustration of a surface water balance during periods of high rainfall: $S_o = P_p - \lambda_i - \Delta W_s$, with $\Delta W_s = E_o$ after rain has ceased

Example 2.2

Another example, based on climatic data in The Netherlands, is presented in Figure 2.2. It concerns a simplified topsoil water balance (1.8) in which I_g , E_o , S_o , R_r and ΔW_s are taken equal to zero:

$$P_p = E_{ra} + L_r + \Delta W_r$$

The drainable surplus of Figure 2.2 is taken equal to the percolation (L_r). The factors are shown in the following table:

	Summer Apr-Aug	Winter Sep-Mar	Whole year
Rain P_p (mm)	360	360	720
Evaporation E_{ra} (mm)	480	60	540
Storage ΔW_r (mm)	-120	+120	0
Percolation L_r (mm)	0	180	180

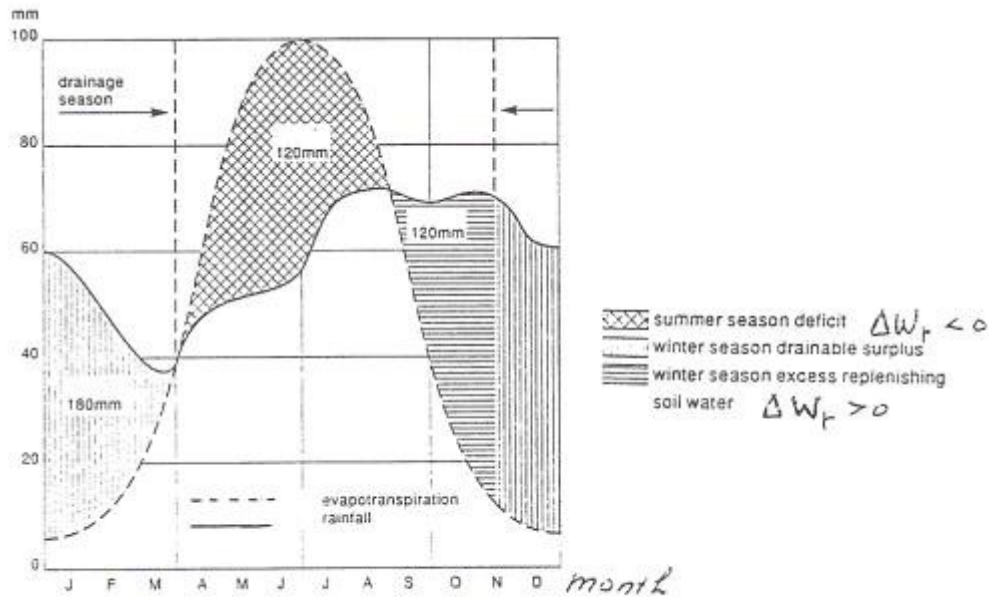

Figure 2.2 Average monthly precipitation and evaporation in The Netherlands

Fixing the drainage season from November up to March (120 days), the average drainable surplus equals the percolation $L_r = 180/120 = 1.5$ mm/day.

Example 2.3

As a third example, a drainage problem is shown in Figure 2.3, which is caused by groundwater flow from a higher irrigated area. The amount of incoming water through the sandy layer can be calculated as:

$$G_{i1} = K_s s_w D_s$$

where:

G_{i1} = discharge in the sandy layer (m^3/day per m width in a direction perpendicular to the plane of the drawing $\rightarrow \text{m}^2/\text{day}$)

K_s = hydraulic conductivity of the sandy soil (m/day)

s_w = slope of the water table (m/m)

D_s = depth of flow in the sandy soil (m)

In the example G_{i1} equals $2 \times 0.01 \times 2 = 0.04$ m^2/d .

The evapo-transpiration and capillary rise from a water table at 0.3 - 0.5 m depth will be a considerable fraction of the potential evapo-transpiration ($E_o = 6$ to 8 mm/d). Estimating the actual evapo-transpiration $E_{ra} = 3.5$ mm/d, the total evapo-transpiration over a length $L = 1000$ m will be

$$E_{RA} = E_{ra}L = 0.0035 \times 1000 = 3.5 \text{ m}^2/\text{d}$$

Since E_{RA} is almost 100 times larger than G_{i1} , it must be concluded that existing drainage problems cannot be caused by the inflow G_{i1} .

There must be an underground flow G_{i2} (see the figure) breaking through the compact clay layer and resulting into a vertical upward seepage ($V_R = 3.5 \text{ mm/d}$) otherwise the water table cannot be maintained at shallow depth.

The clay layer is not impermeable but its hydraulic conductivity is just enough to permit the passage of the vertical upward flow.

It is seen that the water table crosses the clay layer at its downstream part. This is also an indication that the clay layer is not impermeable.

A subsurface interceptor drain, reaching the compact clay layer, would have little influence on the drainage problem.

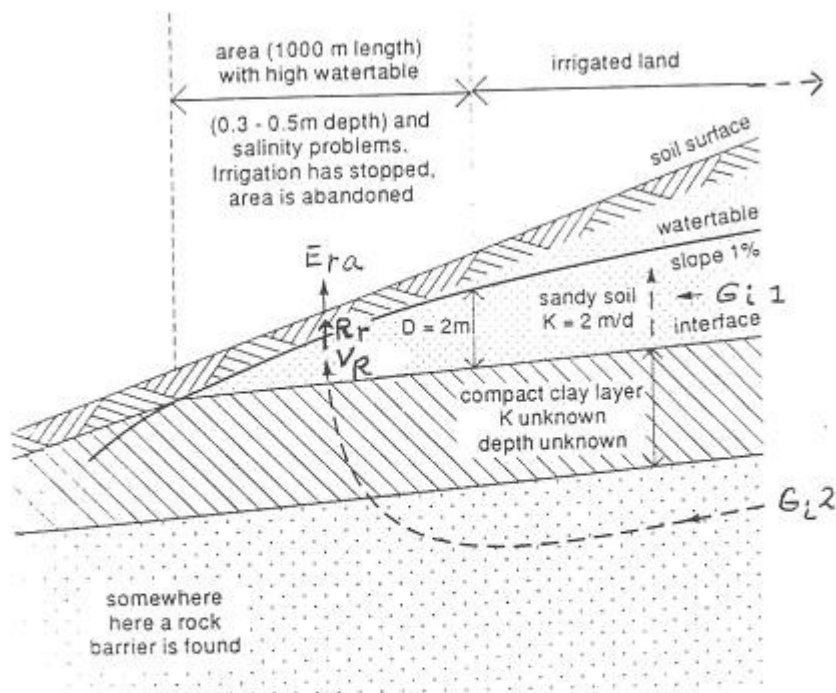

Figure 2.3 Water balance factors in an arid region with subsurface interception drainage problems

Example 2.4

If groundwater breaks through a slowly permeable soil layer, as in Figure 2.4, it may occur, that the vertical upward seepage increases after drainage, at the same time reducing the outflow of groundwater and alleviating the drainage problem downstream of the area drained. This can be explained as follows.

The upward seepage (V_R) can be calculated as:

$$V_R = K_v H_p / D_s \quad \text{m/day}$$

where:

K_v = vertical hydraulic conductivity of the slowly permeable layer (m/day)

H_p = piezometric overpressure in the highly permeable layer (m)

D_s = thickness of the saturated part of the slowly permeable layer (m)

Using suffix 1 and 2 for the situation before and after drainage respectively, it is found that $H_{p2} > H_{p1}$, and $D_{s2} < D_{s1}$, hence: $V_{R2} > V_{R1}$.

If the groundwater flow comes from a far away source, the inflow G_{i1} will be equal to G_{i2} , so that $G_{o2} < G_{o1}$: groundwater is intercepted by the drainage system, and downstream of it the water table is also lowered.

If, on the other hand, the source (e.g. a canal, lake) is nearby, it may happen that $G_{i2} > G_{i1}$: the drains attract additional water from the source.

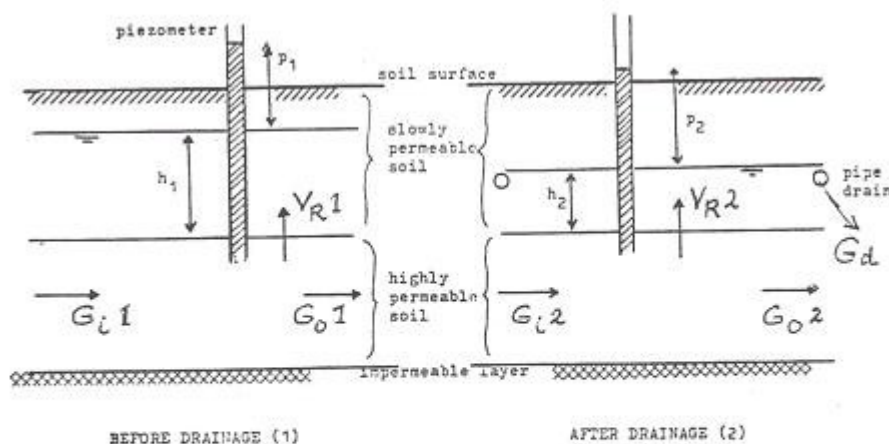

Figure 2.4 Illustrating a semi confined aquifer where lowering the watertable by drainage increases V_R , and reduces G_o .

Example 2.5

Drainage by pumping from wells is often applied in irrigated land with the aim to reuse the drainage water for irrigation. However, at low irrigation efficiencies, the pumping and the subsequent energy losses can be considerable. This can be illustrated by means of a water balance. Let us assume a closed system (Figure 2.5) where surface water is applied (I_f m³/year) for field irrigation. The gross irrigation (I_g m³/year) consists of the surface water brought in by the irrigation canal system mixed with pumped well water (G_w m³/year): $I_g = I_f + G_w$.

Suppose that the consumptive use of the crop equals E_{ra} (m³/year) and the total field irrigation efficiency equals $F_{ft} = E_{ra}/I_g$.

Then, all water not used by the crop becomes deep percolation: $L_r = I_f + G_w - E_{ra}$ or $L_r = (1 - F_{ft})(I_f + G_w)$.

Since this percolation is pumped up again for irrigation use we have: $G_w = L_r$ and $G_w = (1 - F_{ft})(I_f + G_w)$, or:

$$\frac{G_w}{I_f} = \frac{1 - F_{ft}}{F_{ft}}$$

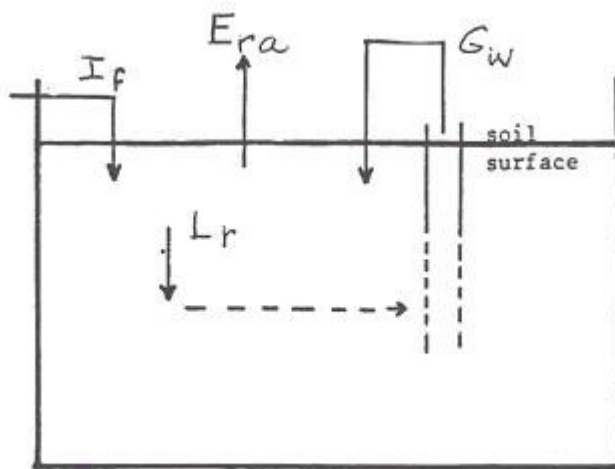

Figure 2.5 Reuse of pumped drainage water for irrigation

Now, the following table can be made

$$F_{ft} = 0.20 \quad 0.25 \quad 0.33 \quad 0.50$$

$$\frac{G_w}{I_f} = 4 \quad 3 \quad 2 \quad 1$$

It is seen that at low irrigation efficiencies the pumping is

several times greater than the surface irrigation. This is due to the fact that a drop of water must, on the average, be pumped around several times before it is used by the plants.

Example 2.6

Infiltration and percolation are often not regularly distributed in the field. Figure 2.6 and 2.7 show some of the irregularities due to variations in soil properties at short distances.

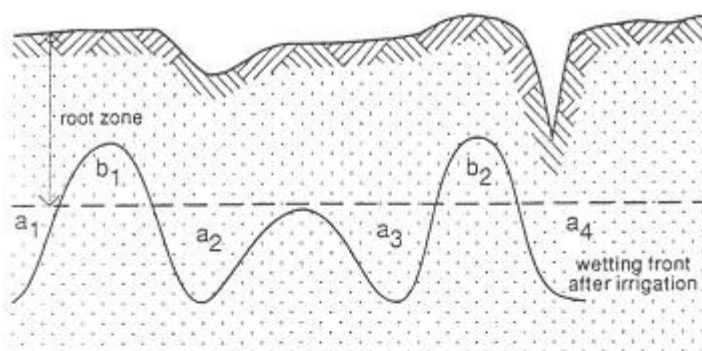

- a₁ excess due to high infiltration capacity
- b₁ shortage due to low infiltration capacity
- a₂ excess due to depression in soil surface
- a₃ excess due to low moisture holding capacity
- b₂ shortage due to elevation of soil surface
- a₄ excess due to cracking

Figure 2.6 Random variation of deep percolation in an irrigated field

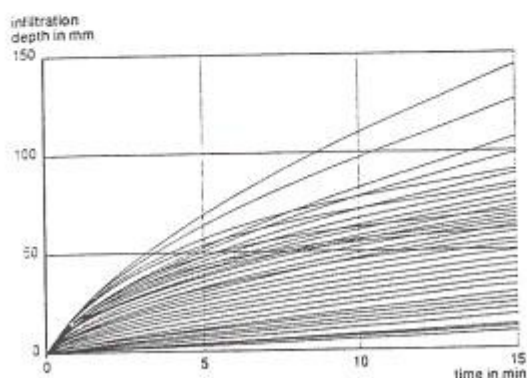

Figure 2.7 Accumulated infiltration versus time measured with 63 infiltrometers set at 1 m spacing on a 7 by 9 m grid in a sandy loam soil (Jaynes et al. 1988)

Example 2.7

This example concerns the collectors for surface drainage systems in sugarcane plantations in the rainy, tropical, coastal region of Guyana (South America). Reference is made to ILRI Publ. 16, page 683 - 685. As the symbols used here are slightly

different, the procedure is repeated with adjusted symbols. The surface water balance (1.2) can be rewritten as:

$$S_o = P_p - \lambda_i - E_o + I_g - \Delta W_s$$

In this example, the term I_g can be set equal to zero. Because we consider a short period with intensive rainfall, the term E_o can also be neglected. Thus the balance can be reduced to:

$$S_o = P_p - \lambda_i - \Delta W_s$$

The Curve Number Method (Chap. 4.4, Publ. 16, ILRI 1994) uses this balance to calculate the runoff. It will be used here.

Table 2.1 shows data of the cumulative 1 to 5-day rainfall with a 10-year return period and the resulting cumulative surface runoff S_{oc} calculated with the Curve Number method, using a Curve Number value of 40.

This empirical method takes into account the storage ΔW_s and infiltration λ_i in the sugarcane fields, but not the temporary, dynamic (live), storage ΔW_d in the fields that is needed to induce the discharge, as will be explained below.

Table 2.1 Example of a rainfall-runoff relationship with a return period of 10 years in example 1.7, using the Curve Number method with a value CN = 40

Duration t (days)	Cumulative rain (mm)	Surface runoff		
		Cumulative S_{oc} (mm)	Daily S_{od} (mm)	Average rate S_{oa} (mm/day)
1	150	14	14	14
2	250	59	45	29
3	325	104	45	35
4	360	128	24	32
5	375	138	10	28

Table 2.1 also shows the daily surface runoff S_{od} and the surface runoff rate S_{oa} as a time average of the cumulative surface runoff: $S_{oa} = S_{oc}/t$, where t is the time or duration in days.

Note that at each time duration: $S_{oc} = \Sigma S_{od}$, where the summation (Σ) is taken over the time periods up to and including the duration considered, and $S_{oa} = \Sigma S_{od}/t$.

The daily dynamic storage ΔW_{dd} can be found from:

$$\Delta W_{dd} = S_{od} - S_{oa}.$$

Table 2.2 shows the development of daily (ΔW_{dd}) and cumulative (ΔW_{dc}) dynamic storage with time ($\Delta W_{dc} = \Sigma \Delta W_{dd}$).

Further, it shows the cumulative surface discharge (Q_{sc}) passing through the drains can be calculated from:

$$Q_{sc} = S_{oc} - \Delta W_{dc}$$

and the daily discharge from:

$$Q_{sd} = S_{od} - \Delta W_{dd}.$$

Note that $Q_{sc} = \Sigma Q_{sd}$.

Table 2.2 Daily and cumulative dynamic storage and discharge derived from Table 2.1

Time (d)	Storage		Discharge	
	Daily ΔW_{dd} (mm)	Cumulative ΔW_{dc} (mm)	Cumulative Q_{sc} (mm)	Daily Q_{sd} (mm)
1	0	0	14	14
2	16	16	43	29
3	10	26	78	35
4	-8	18	110	32
5	-18	0	138	28

It can be seen from Table 2.2 that the daily storage ΔW_{dd} is positive up to the critical time $t = 3$ days, after which it becomes negative. The cumulative storage $\Delta W_{dc} = \Sigma \Delta W_{dd}$ therefore increases up to $t = 3$ days, and afterwards it decreases.

The table also shows that the maximum daily discharge $Q_{sd}(\text{max})$ equals 35 mm/d and occurs during the 3rd day and it also equals the maximum average runoff $S_{oa}(\text{max})$ in Table 2.1.

The design discharge capacity of the main drainage system (35 mm/day or $10 \times 35 = 350 \text{ m}^3/\text{day}$ per ha or $8.64 \times 35 = 302 \text{ l/s}$ per ha) can be therefore chosen as the maximum value of the average surface runoff rate. It occurs after 3 days, which is the critical period because with shorter or longer durations the S_{oa} values are less than 35 mm/d.

The cumulative surface runoff (S_{oc} , Column 3 in Table 2.1) is plotted in Figure 2.8 against the time. It shows a curve with an S-shape. The slope of the tangent line from the origin to

this curve also indicates the required discharge capacity of the collectors, with a return period of 10 years ($\tan a = 35 \text{ mm/d}$).

The S-shape of the runoff curve, which is initially quite flat, shows that the drainage system cannot immediately function at its maximum capacity: there is a delay in the functioning and a necessary dynamic (live) storage.

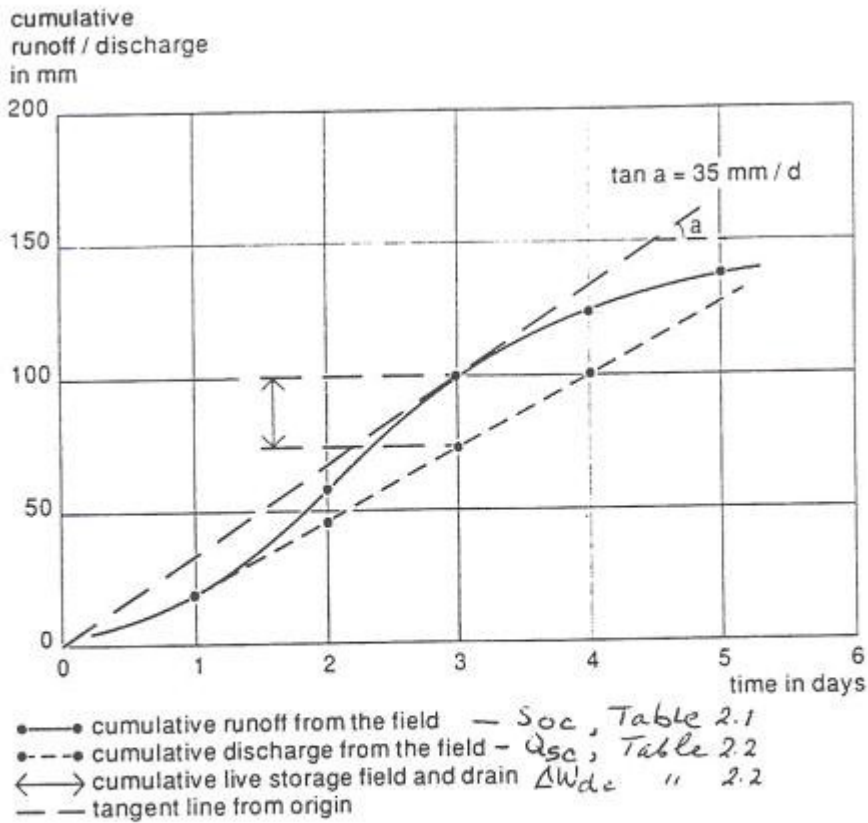

Figure 2.8 Runoff and discharge in time in example 2.7.

3 SALT BALANCES, Leaching

On the basis of water balances it is possible to make salt balances. Using the steady-state agronomic water balance (1.13s), and assuming $E_o = L_c = V_L = S_o = 0$, we obtain the simplified balance as:

$$I_g + P_p + V_R = E_{ra} + G_d \quad (3.1)$$

The simplifying assumptions are often justified when it concerns an irrigated area in a (semi)arid region without natural drainage to the aquifer.

The salt balance is obtained by multiplying the water balance factors with their respective salt concentrations:

$$I_g C_{ir} + V_R C_q = G_d C_d + \Delta Z_{rt} \quad (3.2)$$

where:

- C_{ir} = salt concentration of irrigation water, including the use of drain and/or well water for irrigation
- C_q = salt concentration of groundwater in the aquifer
- C_d = salt concentration of drainage water
- ΔZ_{rt} = increase in salt content of root zone and transition zone

In the above salt balance it has been assumed that the rain P_p contains no salts (i.e. the area is not nearby the sea) and that the uptake of salts by the plants through the evapotranspiration E_{ra} is negligible.

Stating that $\Delta Z_{rt} = 0$ (i.e. allowing no increase in salt content) one finds:

$$I_g = \frac{G_d C_d - V_R C_q}{C_{ir}} \quad (3.3)$$

Using the same simplifying assumptions, the steady-state water balance (1.5s) of the transition zone can be written as:

$$G_d = L_r - R_r + V_R \quad (3.4)$$

The corresponding salt balance is:

$$G_d C_d = L_{rn} C_L + V_R C_q \quad (3.5)$$

where: $L_{rn} = L_r - R_r$ (net percolation, balance 1.16p) and C_L is the salt concentration of the percolating water. Combining salt balances 3.3 and 3.5 yields:

$$I_g = L_{rn} C_L / C_{ir} \quad (3.6)$$

The salt concentration (C_L) of the percolation or leaching water is a function of the salt concentration of the soil moisture in the root zone:

$$C_L = f(C_r) \quad (3.7)$$

This is the leaching efficiency function (Chapter 15.3, Publ. 16, ILRI, 1994). The function represents the effects of the heterogeneity of the soil in vertical and horizontal direction, and the subsequent irregular passage of water and salt through the soil (Figure 3.1).

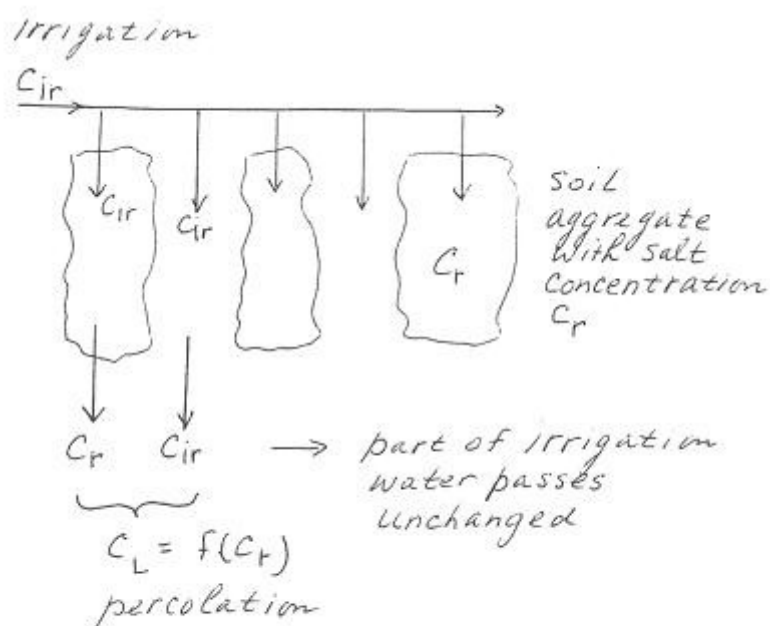
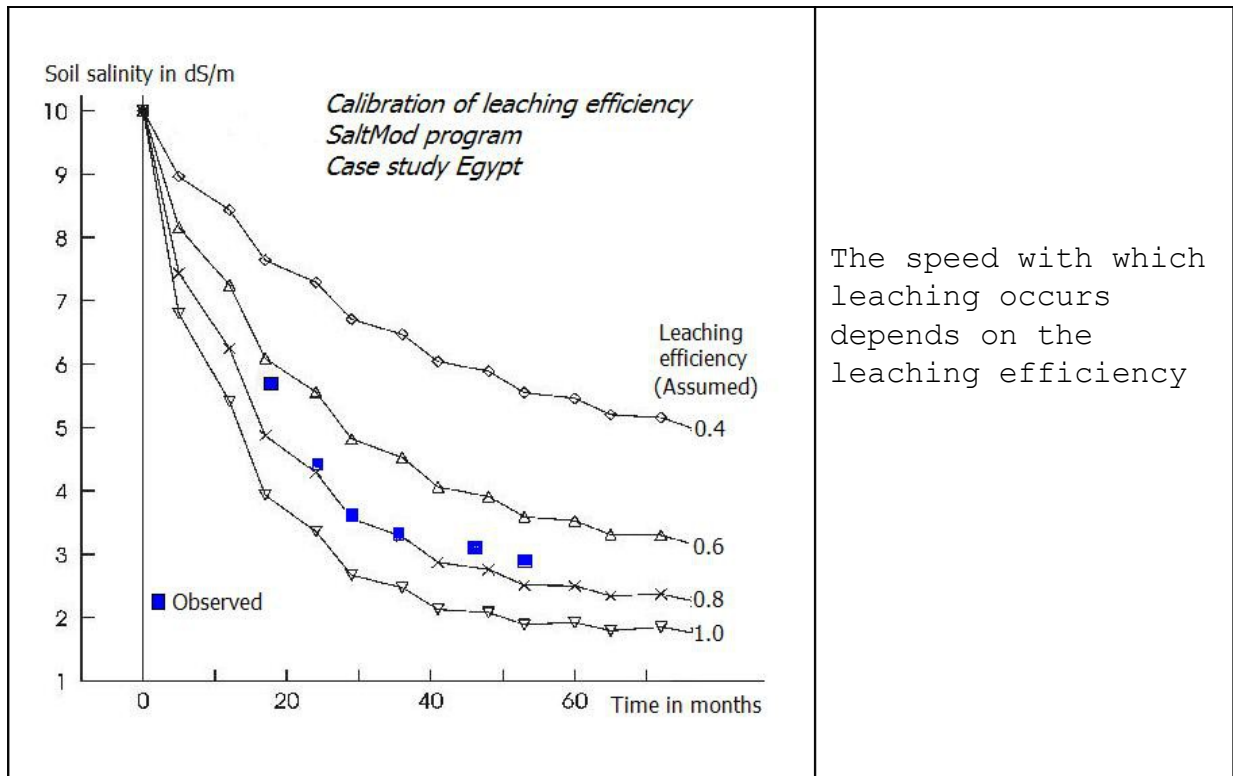

Figure 3.1 The salt concentration of the percolation water depends on the degree of mixing of infiltration water with the soil aggregates



Using Eq. 3.7, the Eq. 3.6 changes into:

$$I_g = L_{rn}f(C_r) / C_{ir} \quad (3.8)$$

Further, using the simplifying assumptions mentioned before, the topsoil water balance in steady state yields:

$$L_{rn} = I_g + P_p - E_{ra} \quad (3.9)$$

The last two equations combined give:

$$I_g = \frac{(I_g + P_p - E_{ra}) \cdot f(C_r)}{C_{ir}} \quad (3.10)$$

After rearrangement, to make the previous equation explicit in I_g , it can be changed into:

$$I_g = \frac{(E_{ra} - P_p) f(C_r)}{f(C_r) - C_{ir}} \quad (3.11)$$

This is the irrigation requirement for salinity control.

From the above formula it is seen that, to maintain a certain permissible salt concentration of the root zone ($C_r = C_{rp}$), the irrigation I_g should be more than $E_{ra} - P_p$ (i.e. there should be excess irrigation) and that more excess irrigation is required as its salt concentration (C_{ir}) increases.

Drainage for salinity control, therefore, can only be helpful if the irrigation is appropriate.

The corresponding drainage discharge can be determined from the agronomic water balance in steady state (1.13s) as:

$$G_d = I_g + P_p + V_R - E_{ra} \quad (3.12)$$

or, after substitution of Equation 3.11:

$$G_d = (E_{ra} - P_p) \frac{f(C_r)}{f(C_r) - C_{ir}} + P_p + V_R - E_{ra} \quad (3.13)$$

From this formula (giving the drainage requirement for salinity control) it is seen that the discharge effect of drainage, rather than its water level effect, governs the salinity control. Hence, for salinity control, the depth of the water table is only of secondary importance.

An exception exists in the situation with upward seepage of salty ground water and subsequent capillary rise during long periods without sufficient irrigation (e.g. fallow land) and rain. Deep drainage is then required to intercept the groundwater before it reaches the root zone, if this is economically feasible, keeping in mind that the land is not productive during fallow periods.

4 EXAMPLES OF SALT BALANCES

Example 4.1

An example of salt balances is given in Figure 4.1, from which it is seen that salinization (salt accumulation) can take place both at relatively shallow and deep water tables. This explains why it is difficult to detect a clear relation between depth of water table and soil salinity (Figure 4.2). Further it illustrates why in arid regions with flat land and scarcity of water it is advantageous for a farmer to apply as much irrigation water as possible; the fallow land of his neighbour then serves as an evaporation pan favouring the salt balance of the irrigated land.

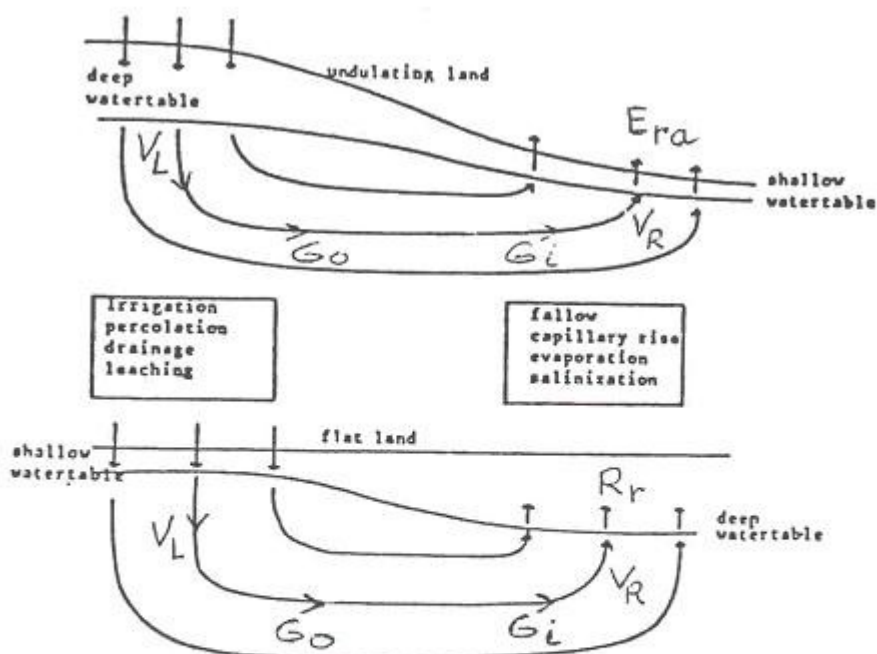

Figure 4.1 Examples of the relation between hydrology and salinization

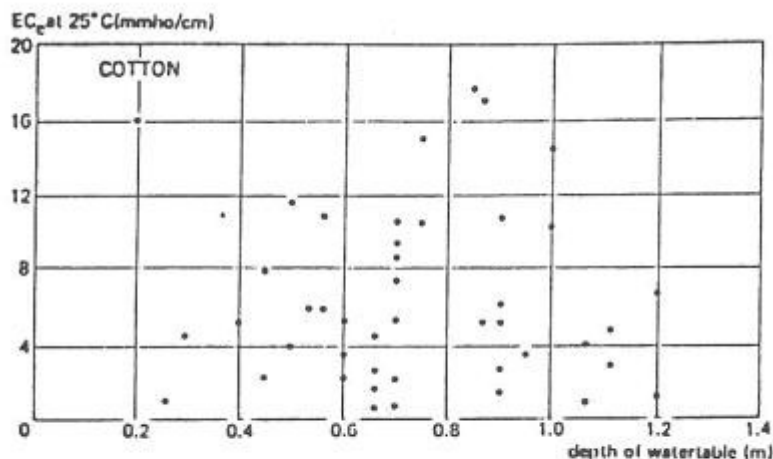

Figure 4.2 Relation between soil salinity (expressed in electric conductivity of saturation extract of topsoil) and depth of watertable at harvest date (Lenselink et al. 1978)

In dry regions with scarcity of irrigation water, the distribution of this water over the area will probably be very irregular, both in time and in space, as follows:

- a) A part of the area will be irrigated with excess water; there will be sufficient leaching; salinity problems are absent; the deep percolation losses will disappear through seepage, capillary rise and evaporation in neighbouring fallow land;
- b) A part of the area will be irrigated with an insufficient amount of water; no leaching will take place and salinity problems will develop, even when there is no upward seepage of groundwater.
- c) A part of the area is not irrigated (fallow); salinity problems may or may not develop dependent on the presence or absence of upward seepage;
- d) Some parts of the area are permanently irrigated, other parts are only seasonally irrigated, and the remaining parts are either irrigated once in a number of years or hardly ever.

Efficient salinity control in areas with scarce irrigation water, therefore, is primarily a matter of efficient management of irrigation water. Drainage is only a complementary activity. It would make little sense to drain fields that are not irrigated yearly or that have no drainable surplus even when irrigated. Sometimes it is advisable not to install a drainage system at all, but to use the permanently fallow land as "evaporation pan" for the drainage water from irrigated fields (see a.), if this is socially acceptable.

In the irrigation management, not only the application of the correct amount of irrigation is important but also the land levelling.

This is illustrated in Figure 4.3 showing poorly levelled land.

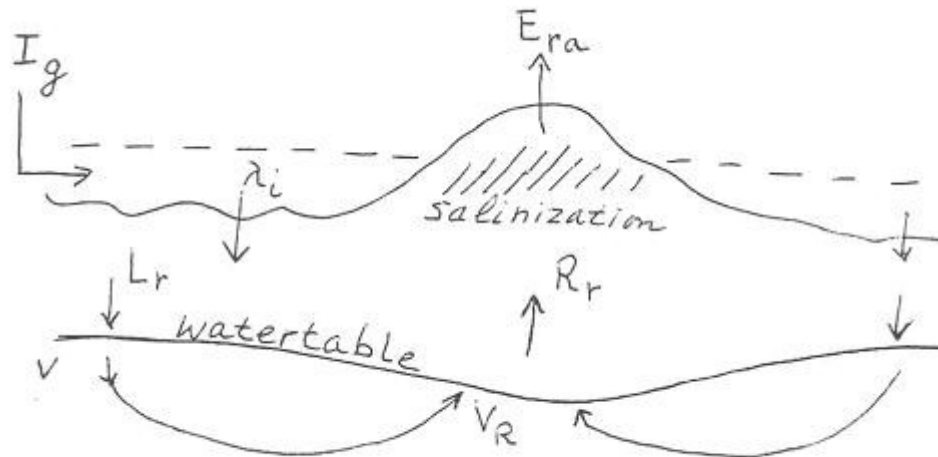

Figure 4.3 Example of salinization in uneven land.

Example 4.2

In Figure 4.3 it is seen that little irrigation water infiltrates in the higher part of the irrigated field. Here, the water table is relatively deep. In the lower part of the field the infiltration is much more, and the water table is relatively high. As a result, groundwater moves from the lower part of the field to the higher part. The lower part has sufficient percolation and natural drainage to maintain a favourable salt balance. In the higher part, however, no leaching occurs. On the contrary, it receives seepage water from the adjacent lower parts and, since the soil in the higher part is dry, the seepage water enters the root zone by capillary rise which is followed by evaporation.

Hence, salt accumulation and salinization occurs in the higher part. This also indicates that, if the land is irrigated by furrow systems, it is necessary to reshape the furrow system from time to time, otherwise salt keeps accumulating in the furrows.

Not only differences in topography, but also spatial differences in infiltration capacity or water holding capacity of the soil, as shown in Figures 2.6 and 2.7, lead to a patchy development of the salinity in an irrigated field. Therefore, a little over-irrigation is necessary from time to time, to secure proper leaching of the parts having high water holding capacity or low infiltration (Fig. 4.4).

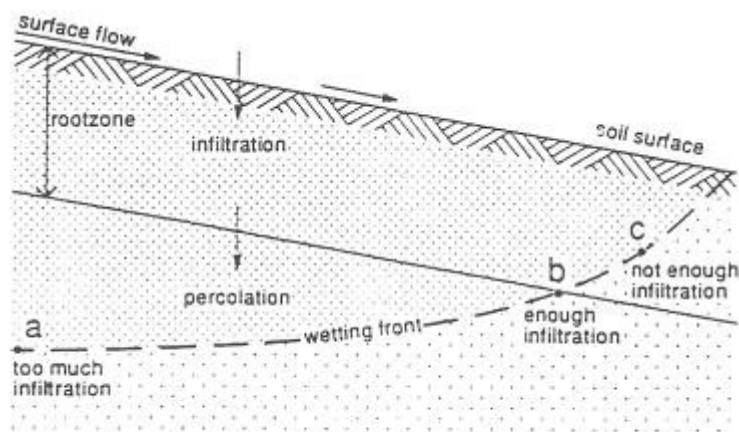

Figure 4.4 Systematic irregularity in spatial distribution of percolation in an irrigated field.

Example 4.3

Salt balances can be calculated for a series of years, assuming different water management practices. An example of salinity calculations for 30 years is given in Figure 4.5, in which the irrigation and the pumping of groundwater is made variable, but the drainage system remains as it was in the first year.

Note that the symbols used in the figure deviate from those used previously.

The figure shows that 20% more irrigation water during the dry winter season would accelerate the desalinization of the root zone (line SR/RU/AI). Conversely 20% less irrigation water reduces the speed of desalinization considerably (upper line SR/RU/RI). The salinity of the root zone is higher at the end of the hot monsoon season than at the end of the winter season (compare lines SR/RU/M and SR/RU/D). Apparently the amount of rainfall during the monsoon season is not sufficient to prevent a slight resalinization. Further the figure shows that the use of pumped groundwater retards the desalinization (compare lines SR/RU/M and SR/NP), but it speeds up the reduction of the salt concentration in the drainage water (compare lines SD/RU and SD/NP).

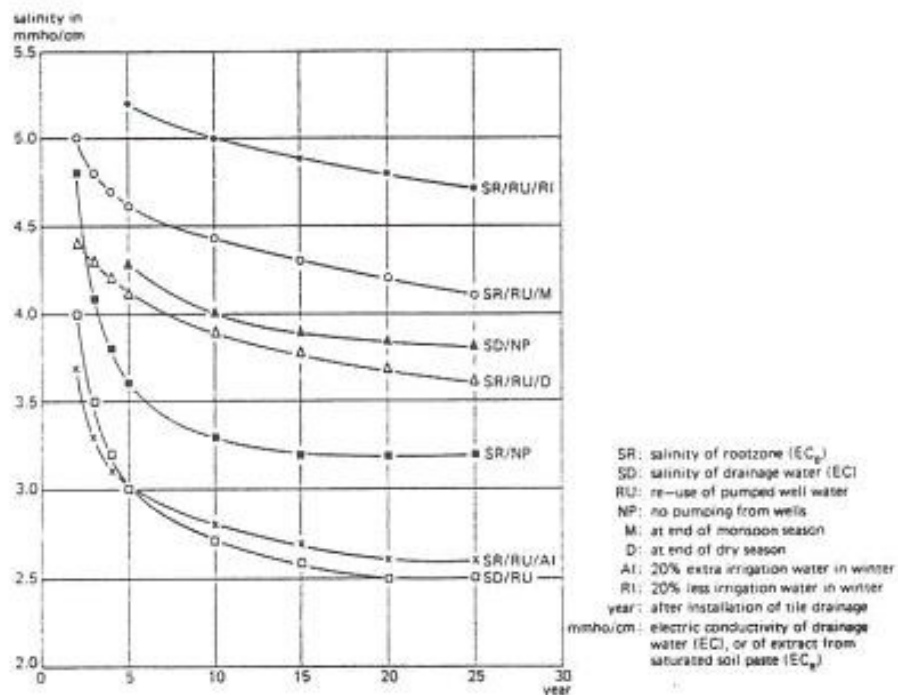

Figure 4.5 Example of the prediction of water and soil salinity under different water management options using water and salt balances in the Mundlana Pilot Area, Haryana, India (from the work of O.P. Singh, see ILRI Annual Report 1987)

Example 4.4

An example of the application of Equation 3.11 is given below and illustrated in Figure 4.6.

In an area there is an irrigation season of 100 days followed by a rain fed cropping season (265 days). The water balance factors during these periods are shown in Figure 4.6 and in the following table 3.1.

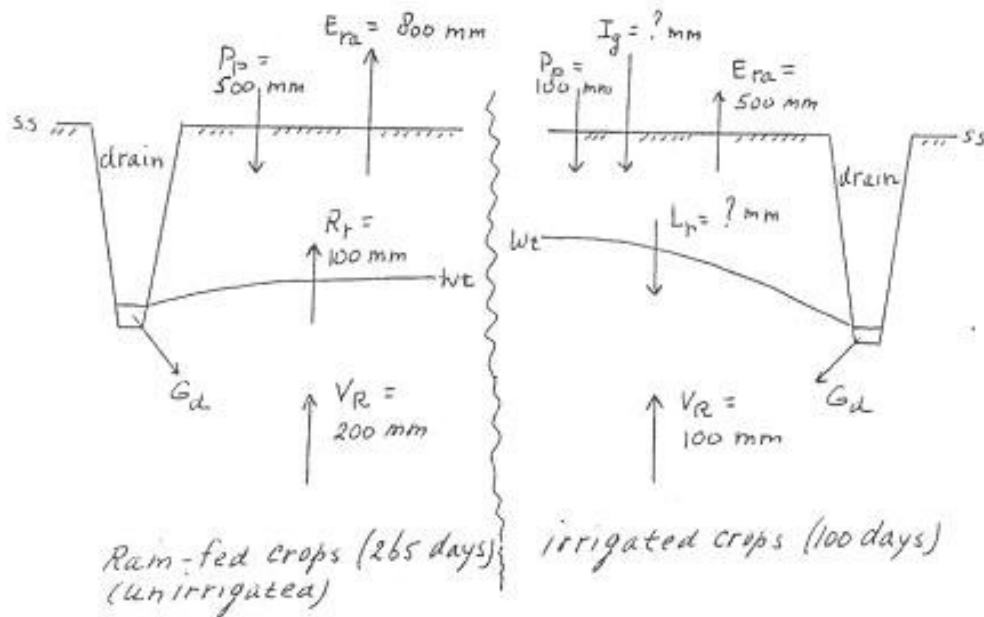

Figure 4.6 Illustration of water balance factors in an area with an irrigation and non-irrigation season as used in the example of application of Equation 3.11 (ss = soil surface; wt = watertable)

Table 3.1 Water balance factors of Figure 4.6

Irrigation season		Rain fed season (un-irrigated)	
P_p	= 100 mm	P_p	= 500 mm
E_{ra}	= 500 mm	E_{ra}	= 800 mm
V_R	= 100 mm	V_R	= 200 mm
I_g	= ? mm	I_g	= 0 mm
ΔW_r	= ? mm	ΔW_r	= ? mm
L_r	= ? mm	L_r	= ? mm
R_r	= ? mm	R_r	= 100 mm
G_d	= ? mm	G_d	= ? mm
C_{ir}	= EC = 1 mmho/cm or dS/m		

The leaching efficiency function $f(C_r)$ is taken simply equal to C_{rp} (i.e. the salt concentration of the percolation water equals the permissible salt concentration C_{rp} of the soil moisture in the root zone), and the permissible salt concentration of the soil moisture in the root zone is fixed as $EC = C_r = C_{rp} = 8$ mmho/cm or dS/m.

Applying equation 3.11 using the data of the whole year we obtain the irrigation requirement for salinity control as:

$$I_g = (500 + 800 - 100 - 500) \times 8 / (8 - 1) = 800 \text{ mm}$$

This amount of irrigation water is required to:

- cover the consumptive use of the crop in the irrigation season: $E_{ra} - P_p = 500 - 100 = 400 \text{ mm}$;
- replenish the soil moisture that has been used by the crops in the non-irrigation season:

$$\Delta W_r = E_{ra} - P_p - R_r = 800 - 500 - 100 = 200 \text{ mm};$$

- leach the salts that have been brought in by the capillary rise in the non-irrigation season;
- leach the salts that have been brought in with the irrigation water.

Since 1 mmho/cm or 1 dS/m (the salt concentration of the irrigation water) corresponds to roughly 0.6 g salt/l water = 0.6 kg salt per m^3 water, and since per ha annually $0.800 \text{ m} \times 10000 \text{ m}^2 = 8000 \text{ m}^3$ of irrigation water is applied per ha, this means that actually $0.6 \text{ kg/m}^3 \times 8000 \text{ m}^3 = 4800 \text{ kg}$ of salt per ha is introduced to the land by irrigation, and these salts need also to be leached annually if no salt accumulation is to take place ($\Delta Z_{rt} = 0$).

The yearly net percolation is found from $L_{rn} = L_r - R_r$ or from: $L_{rn} = I_g - (E_{ra} - P_p) = 800 - (500 + 800 - 100 - 500) = 100 \text{ mm}$ which is about 12% of the irrigation.

The yearly total amount of drainage water is:

$$G_d = L_{rn} + V_R = 100 + 300 = 400 \text{ mm}$$

The required seasonal drainage discharge rates per day rate are:

- Irrigation season (with positive storage):

$$(I_g + P_p + V_R - E_{ra} - \Delta W_r) / 100 \text{ days} =$$

$$(800 + 100 + 100 - 500 - 200) / 100 = 3 \text{ mm/day};$$

- Rain fed season:

$$(P_p + V_R - E_{ra} - \Delta W_r) / 265 \text{ days} =$$

$$(500 + 200 - 800 + 200) / 265 = 0.38 \text{ mm/day};$$

so that the irrigation season is the critical period for drain design.

NOTE 1

The permissible soil salinity in the balance refers to the field saturation or soil moisture content at field capacity. The EC value of a saturated paste in the laboratory contains about twice as much water. So the ECE of the extract of the paste would be about $8/2 = 4$ mmho/cm or dS/m.

NOTE 2

If the irrigation requirement for salinity control is calculated only with the data of the irrigation season, one obtains:

$$I_g = 457 \text{ mm, instead of } 800 \text{ mm.}$$

Using $I_g = 457$ mm, and taking the water balance of the non-irrigation season into account, this would result in a salt concentration C_r greater than the permissible salt concentration C_{rp} assumed at $EC = 8$ mmho/cm or dS/m. In fact, when $I_g < 700$ mm (the total evaporation minus the rainfall), there can be no equilibrium value of C_r , but it will increase continuously.

It is concluded, therefore, that salt balance calculations should be made for longer periods of time, instead of for seasons only, especially when the upward seepage of ground water and the seasonal storage plays an important role.